



Humboldt ShearTester

## **Introduction**

### **Applications:**

#### **Determination of the shear strength of soils by the direct shear method:**

The direct shear test, specified in ASTM D3080, has been used extensively in soils laboratories since the late 1930s. The test requires that either a square or circular prism of soil be laterally restrained and subjected to a pressure that is normally applied to that shear plane. Shearing resistance imparted by the soil as one portion is forced to slide over the other and is measured at regular intervals of displacement. Once the shearing resistance of the soil has reached its maximum value, failure occurs.

Commonly 3 tests are conducted on smaller soil specimens using different normal pressures vertical to the shearing plane. This allows the relationship between the measured shear stress at failure and the applied normal stress to be calculated. The apparatus in this manual permits test to be conducted on soil specimens of 60mm and 100mm, which are 25mm (maximum height) and for specimens of 2.5 inches by 1 inch in height.

### **Test Type**

The HM-2750A Series of Direct Shear machines are designed for performing drained shear tests for the determination of effective shear strength parameters. No means are incorporated to allow for drainage, thus the apparatus cannot be used for conducting un-drained tests.

The specimen is contained within two halves of the shear box and is subjected to primary consolidation before carrying out the shear stage. Once the primary consolidation is completed, the specimen is then sheared at a selected strain rate so as to ensure that excess pore pressure does not develop. The collected data allows the user to determine the effective shear strength parameters  $c'$  and  $0'$ . By reversing the shear force and reshearing the specimen, the user can obtain the residual shear strength parameters.

## 2

The principle conditions under which the tests should be conducted are as follows:

- The size and shape of the test specimens
- Whether undisturbed or remolded soil specimens are to be tested
- The orientation of the specimens relative to the shear plane (undisturbed specimens)
- The moisture content, compacting effort and drying density to be achieved must be specified for remolded samples.
- Total number of test specimens to be tested per set
- Normal pressures to be exerted for the series of tests
- Whether the residual strength is required and the method of obtaining the residual reversal facility

It manages the control of a stepper motor driven platen at speeds from 0.00001 to 0.49999 in/min (or equivalent 00.00001 to 12.99999) with provision for Fast movement actions. This allows the instrument to carry out soil tests under Strain control.

- Support for up to either 4 analogue transducer inputs covering the range a to 100 m V suitable for most Load, and displacement devices or 4 digital dial indicators inputs. Configuration and Calibration facilities are provided, and all-important data is stored in non-volatile memory for safe preservation.
- Complete Data logger capacity for test made up of any of the channels above. All tests are fully configurable for automated Start, Stop and Log-rate conditions and can hold up to 1000 readings per test.
- An LCD screen and 9 key membrane panel allows presentation of results, parameter configuration, machine control and other selections to be made easily. Some of the most important parameters can only be changed under pass code control to protect against operator misuse.
- Serial port communications with a remote Humboldt download program.

**The standard apparatus consists of the following:**

A gearbox-driven horizontal screw ram and geared jack upon a rigid stand and horizontal base. The gearbox and motor are used with the stepless speed control box.

The control box is situated on the front, to the left of the metal stand. To avoid the need of calibration charts and to maximize the ease of desired speed selection, the speed control of the apparatus is calibrated in inch/min (engineering units), which are indicated digitally.

The main base also incorporates a vertical support bracket, to guide the spindle of the selected means of reactive measurement of the applied shear force. (force indicators H-4454.XXX are not included and must be selected from the Humboldt Mfg. Co. range). There is a reaction bracket at the rear of the base, against which the load ring or measurement device is pushed.

The shearboxes are equipped with a carriage mounted on linear ball races resting upon sliding tracks. When mounted, the carriage is transversely restrained but is free to glide axially along the centerline of the geared jack and reaction bracket. Affixed to the geared jack is the vertically mobile dial gauge arm. The dial gauge arm mounts an anti-clockwise dial gauge allowing for direct visual measurement of the consolidation of the sample.

Shearbox squares are not included with the standard apparatus, though can be purchased separately as an accessory.

The method of normal stress application, on the standard apparatus, is by a vertical load hanger resting above the soil specimen and hanging downwards permitting the selected weights to rest upon its load mount, while traveling with the upper specimen half, (should any lateral movement take place). The consolidation force is applied to the specimen proportionally by the amount of weights placed upon the hanger mount.

The load ring and dial gauges are necessary to perform the shear testing procedure and are supplied as extras. The shear force is obtained by the geared jack moving along the axis of the base in an attempt to move the carriage and the slightly separated halves of

#### 4

the shearboxes. The upper half of the specimen is connected to a bracket at the opposite side of the geared jack. This bracket requires a measuring device to provide an opposing force to the upper shearbox half, affixed to the reaction bracket of the base.

The standard measuring devices are the load ring and dial gauges. The load rings are of either 2kN or 5kN capacity. Each load ring is supplied with a dial gauge for measuring deflection in the load ring. One additional dial gauge is required to measure the displacement of the upper and lower shearbox halves.

The power ON/OFF switch is located at the rear of the apparatus. When it is switched "ON" the Liquid Crystal Display (LCD) is illuminated.

# Manufacturer's Rights and Responsibilities

## Software Copyright

COPYRIGHT NOTICE

©2005 HUMBOLDT MFG. CO.

All Rights Reserved.

This manual or parts thereof, may not be reproduced in any form without the expressed written permission of HUMBOLDT MFG. CO.

UNPUBLISHED LICENSED PROPRIETARY WORK

©2005 HUMBOLDT MFG. CO.

The programmable, read-only memory, integrated circuit package contained in this equipment and covered with a copyright notice label contains proprietary and confidential software, which is the sole property of HUMBOLDT MFG. CO. It is licensed for use by the original purchaser of this equipment for a period of 99 years. Transfer of the license can be obtained by a request, in writing, from HUMBOLDT MFG. CO.

With the exception of HUMBOLDT Authorized Service Facilities you may not copy, alter, de-compile, or reverse assemble the software in any fashion except as instructed in this manual. US copyright laws, trademark laws, and trade secrets protect the materials.

Any person(s) and /or organizations that attempt or accomplish the above violation or knowingly aid or abet the violation by supplying equipment or technology will be subject to civil damages and criminal prosecution.

**IMPORTANT NOTICE**

The information contained herein is supplied without representation or warranty of any kind. Humboldt MFG. CO. therefore assumes no responsibility and shall have no liability, consequential or otherwise, of any kind arising from the use of the described equipment contained in this manual.

**Updated products**

The manufacturer reserves the right to change or modify product design or construction without prior notice and without incurring any obligation to make such changes and modifications on products previously or subsequently sold.

**Fitness for application**

The manufacturer makes no recommendations or claims regarding fitness for applications other than the specific tests as defined in this User Guide.

**General Warnings****Safety Warnings**

Operators should take care to operate this machine under the maximum load restrictions. The machine is programmed at the factory to provide safety shutdown if the upper or lower maximum travel is exceeded.

**Electrical Warnings**

Typically, there is no reason for the operator to open the machine. However, if the customer's engineers attempt to change settings to the circuit board connected to the back panel, the machine must always be unplugged before this operation. Unplugging the internal connection to the back panel circuit board while the machine is under power will result in permanent damage to the circuit board.

# Installation and Set-up

## Unpacking

Initial inspection should include checking for physical damage during shipping and obvious external damage to the product.

Package contents are defined by your packing list. Make certain that the contents of your shipment match the documentation provided by your packing list.

## Setup

1. Unclamp the counterbalance lever-loading arm by undoing the beam jack.
2. Screw in the consolidation dial gauge arm and associated pillar to the machine.
3. Place ball races on track.
4. Place carriage assembly on ball races, placing slotted end over the geared jack.
5. Locate proving ring between bracket and carriage body (the reaction bracket has a ball socket for clamping) by screwing to the proving ring threaded blocks, utilizing the adapters provided. The dial gauge should be compressed to its midway position (approximately 5mm) by the adjusting screws in the proving ring.

## Electrical Connections

Humboldt HM-2750 Series controllers are equipped with an internal, digital, switching power supply, which allows them to be used with most power configurations throughout the world. The units are supplied with an IEC electrical cord with a standard 110V USA plug.

HM-2750 Series Controllers arrive ready for operation. Attach the controller to top of motor housing with supplied velcro fasteners. Attach the supplied IEC electrical cord to the machine and plug into a standard wall receptacle for use in the United States.

For locations other than the U.S., replace the supplied electrical cord with an IEC cord with the correct plug for your application. The supplied cord can also be used by cutting the standard plug from the cord and attaching the correct plug.



### **Instrument Inputs (load cell/transducer connections)**

Models HM-2750A and HM-2750D have 4 instrumentation inputs located on the back panel to accommodate load cell/transducer connections. This feature allows you to set up and calibrate up to 4 different instruments, which the unit can quickly switch between for those needing to do multiple tests.

Third-party load cells/transducers, which are compatible, can also be used with the HM-2750 Series. Compatible units will have an excitation voltage of 0-10 volts and an output of 0-100 millivolts. Prior to use all third-party instrumentation must be configured and calibrated for use. Please refer to the Configuration and Calibration sections of this manual.

If you are using third-party cables for transducer connections, make sure they are wired to be compatible with the HM-2750. Consult Figure #1 for a compatible reference wiring diagram. Plugs to connect third-party instrumentation to the Humboldt HM-2750s are available, order part HM-000474.

### **Preparation and Loading Procedure**

1. Place test samples in carriage and tighten clamp screws on assembly. Remove the two lock screws from the squares and then turn down and bring back the two other screws to split the sample.
2. Raise and locate the crossbar on top pad in vertical position, This verticality is achieved by adjusting the carriage position. Raise beam jack to hold loading arm so that no load can be applied to the sample. Add weights to give the necessary stress while the beam is secured.
3. Locate and fix top screws on crossbar and locate consolidation dial gauge, (add water at this point). Beam position should be level.
4. Release beam jack and consolidate sample.
5. Shearing preparation:
  - a. Take up slack by adjusting lock nuts on the reaction bracket.
  - b. Position strain dial gauge on bracket. (dial gauge should be fully compressed) .
  - c. When required, re-select travel direction by switching "S" button and before operating the "F or R" switch in the direction of travel, release the direction bracket screw to take load out of proving ring. The dial gauge in this zero load condition should be compressed to its midway position.

Pin1= +10Vdc Excitation  
 Pin2= 0Vdc Excitation  
 Pin3= +dc Output  
 Pin4= -dc Output

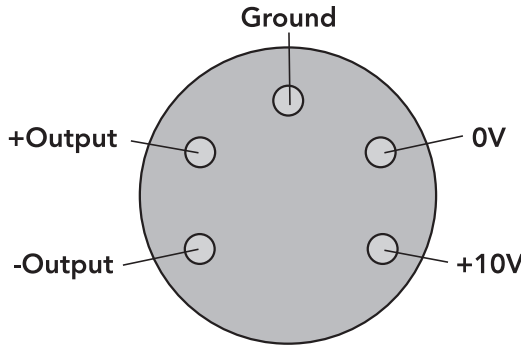

Figure 1. Compatibility wiring diagram for 3rd party cables

## Computer Connection

Humboldt HM-2750A and HM-2750D Controllers can be connected to a PC computer to take advantage of Humboldt's HMTS software capabilities, conduct real time data logging and enhanced report generation. This is accomplished via the RS232 port on the back panel of the machine (refer to Figures 2 & 3). Use a RS232 cable (supplied) and attach it between the computer's RS232 port and the MiniLogger.

The minimum compatible computer configuration is a PC with Pentium III 550 MHz processor, 512 MB of RAM and a 40GB hard drive running Windows® XP Professional system software.

## Additional Device Connection

Additional devices, such as additional HM-2750s and/or HM-3000 Load Frames, MMiniLoggers, and other computer-compatible load frames can be connected to a computer via the RS-485 port on HM-2750A and HM-2750D models. This allows you to daisy-chain several devices to the same computer. Use a standard CAT 5 cable (not included) to link the additional device's output port to the HM-2750's RS-485 input port (refer to Figures 2 & 3). Dip switches and rotary switch need to be set to primary or secondary usage (see Figure 5).

## Analogue Device Connection

Humboldt MiniLoggers can be set up to output directly to a chart recorder to provide a hard copy printout of test results. To accomplish this, connect your chart recorder via cable attached to the HM-2750's analogue port on the back panel of HM-2750 A or D controllers (see figure 7).

Figure 2A. Rear panel of HM-2750A showing the four Analogue instrumentation channel inputs, the Analogue Port, RS232 Port, RS-485 Input and Output, the On/Off Switch and the motor cable input.

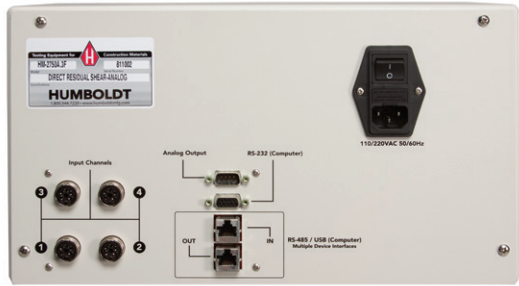

HM-2750A

Figure 2B. Rear panel of HM-2750D showing the four Digital instrumentation channel inputs, the Analogue Port, RS232 Port, RS-485 Input and Output, the On/Off Switch and the motor cable input.

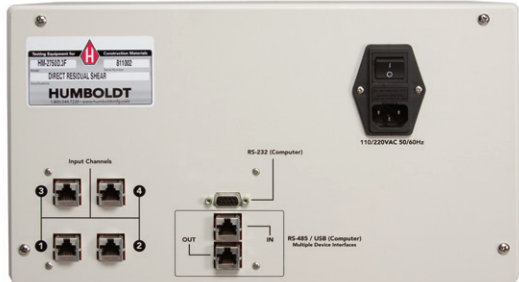

HM-2750D

Figure 2C. Rear panel of HM-2750 showing the On/Off Switch and the motor cable input.



HM-2750

ANALOG PORT ACCESS

Cable configuration for analogue port access.  
Pins 1, 2, 3 & 4 (Reserved for Humboldt Chart Recorder)

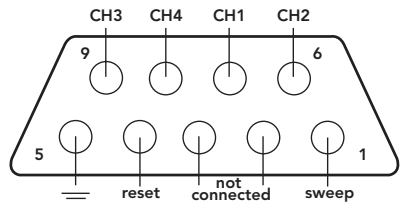

D-SUB, 9-PIN MALE

Figure 3. Rear panel of MiniLogger showing Analog Port, RS232 Port, RS-485 Input and Output and the four instrumentation channel inputs.

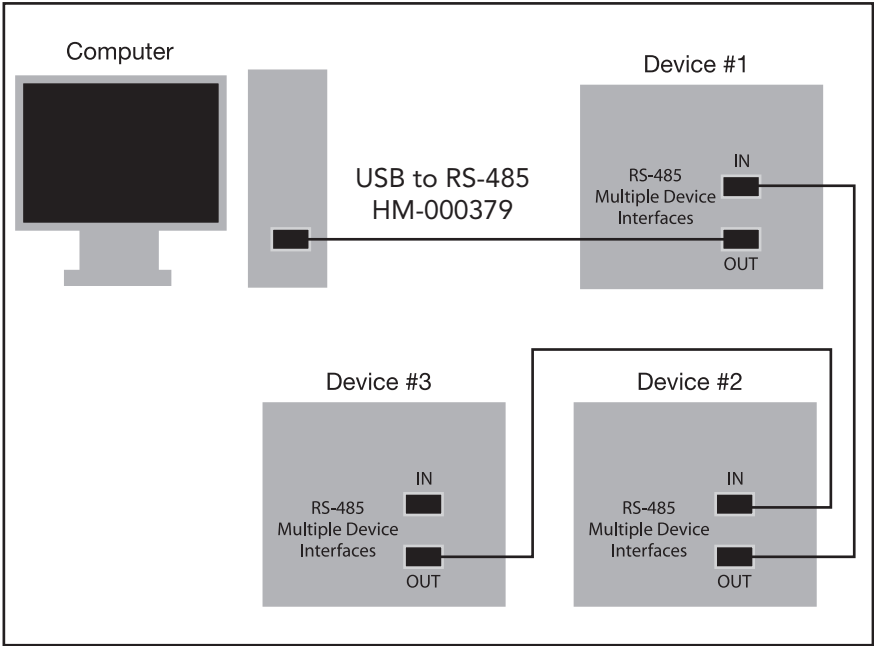

Figure 4. Diagram illustrating computer and multiple device connections.

## Operation

### Power Switch

The Power Switch is located in the back panel on the rear of the HM-2750 controller above the electrical cord inlet. Also, located between the electrical cord inlet and the Power Switch is the Fuse Compartment. Humboldt HM-2750s use a 10 amp fuse. To begin operation, press the Power Switch.

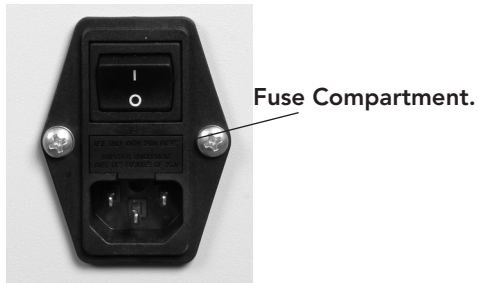

Figure 6. HM-2750 Power Switch, Electrical Cord Inlet and Fuse Compartment.

## Key Functions

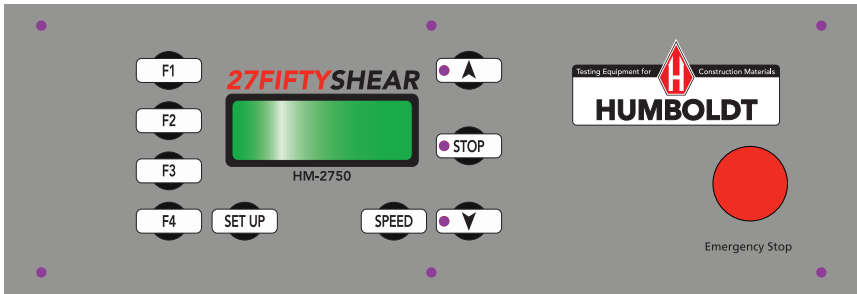

Figure 5. HM-2750 Series Front Control Panel

SET UP

### Set Up Key

Pushing the Set Up Key brings up the main set up screen from which you can run a test, review your last test, access the engineering set up menus and set the date, time, units, standards criteria. This key also is used to return to a previous screen.

SPEED

### Speed Key

Pushing the Rate Key allows you to change the selected platen speed between 0.00001 and 0.499999 inch/min.

STOP

### Stop Key

Pushing the Stop Key stops the machine.



### Forward Key

Pushing the Forward Key moves the shear box to the right. Also, by holding down the Key, the machine will move forward at the fast rate of 0.5 in/min. Releasing the key changes the machine's speed back to its set rate.



### Reverse Key

Pushing the Reverse Key moves the shear box to the left. Also, by holding down the Key, the machine will move in reverse at the fast rate of 0.5 in/min. Releasing the key changes the machine's speed back to its set rate.

F1**Function Keys**F2

The four function keys are used to navigate through the MiniLoggers' menu-driven display. The function keys correspond with the command lines on the menu display. F1 corresponds with the first command line; F2, the second, etc. Command lines that are active in any display will be preceded by an (\*). If no (\*) is present, the corresponding function key is not active.

F3F4

## Set-up Functions (all models)

### Set Date

To set the Date press  until you see this screen:



\* REVIEW LAST TEST  
 \* RUN TEST  
 \* ENGINEERING SETUP  
 \* SET DATE/TIME/UNITS/STND

Press  (SET DATE/TIME/UNITS/STND). You should see this screen:

\* SET DATE  
 \* SET TIME  
 \* UNITS = ENG/METRIC

Press  (SET DATE). You should see this screen:

DATE = "MM/DD/YY"  
 \* INCREASE  
 \* DECREASE

Press  (DATE) to select the month/date/year. Press  (INCREASE) or Press  (DECREASE) to change the appropriate number.

To return to any prior screen you can always press .

### Set Time

To set the Time press  until you see this screen:

\* REVIEW LAST TEST  
 \* RUN TEST  
 \* ENGINEERING SETUP  
 \* SET DATE/TIME/UNITS/STND



Press  (SET DATE/TIME/UNITS/STND). You should see this screen:

\* SET DATE  
\* SET TIME  
\* UNITS = ENG/METRIC

Press  (SET TIME). You should see this screen:

TIME = “HH/MM/SS”

\* INCREASE  
\* DECREASE

Press  (INCREASE). or Press  (DECREASE) to change the appropriate number.

To return to any prior screen you can always press 

### Set Units

To set the Units the HM-2750 will use to display results, press  until you see this screen:

\* SET DATE  
\* SET TIME  
\* UNITS = ENG/METRIC  
\* STANDARD = ASTM/BS

Press  (UNITS) to toggle between English and Metric Units. Select the units desired—the flashing units are the active choice.

To return to any prior screen you can always press 

## Set Standards

To set the Standards the HM-2750 will use, press  until you see this screen:

\* REVIEW LAST TEST  
 \* RUN TEST  
 \* ENGINEERING SETUP  
 \* SET DATE/TIME/UNITS/STND

Press  (SET DATE/TIME/UNITS/STND). You should see this screen:

\* SET DATE  
 \* SET TIME  
 \* UNITS = ENG/METRIC  
 \* STANDARD = ASTM/BS

Press  (STANDARD) to toggle between ASTM and BRITISH STANDARD.







Select the standard desired—the flashing standard is the active choice.

To return to any prior screen you can always press .

## Rate (Motor Speed Adjust)

To set the speed of the HM-2750 press  You should see this screen:

MOTOR SPEED ADJUST  
 \* SPEED = "X.XXXX"  
 \* INCREASE  
 \* DECREASE

Press  (SPEED) to move between the numbers. Keep pressing  until the digit you want to change is flashing. Once you have selected the number you want to change, press  (INCREASE) or  (DECREASE) to change the number to the desired value. Once you have set the speed, press the  or  to activate it.

## Channel Configuration (Models A and D only)

If you are adding new instrumentation, changing existing instrumentation or reconfiguring the HM-2750's channel setup, you need to configure the channel for use with the devices you have.

To configure a channel, press  You should see this screen:

- \* REVIEW LAST TEST
- \* RUN TEST
- \* ENGINEERING SETUP
- \* SET DATE/TIME/UNITS/STND



Press  (ENGINEERING SETUP). You should see this screen:

- \* CONFIGURATION
- \* CALIBRATION
- \* SAMPLING INTERVAL
- \* MANUFACTURES INFO

Press  (CONFIGURATION) You will be asked for a password, enter:

     You should see this screen:

- CONFIGURATION screen
- \* SELECT CHANNEL "CH1"
  - \* CONFIGURE CHANNEL
  - \* CONFIGURE TEST



Press  (SELECT CHANNEL) to scroll through and choose the channel you wish to configure. Once you have selected a channel press  (CONFIGURE CHANNEL). You should see this screen:

- "CH1" CONFIGURATION
- \* NAME = "CH1"
  - ENG MIN = 0
  - \* ENG MAX = "VALUE"

### Naming Channel (Models A and D only)

From the previous screen, shown above, Press  (NAME) to select the name you wish to change, press the key until the name you wish to change is indicated. You should see this screen:

“CH1” CONFIGURATION  
 \* NAME = “CH1”  
 \* INCREASE  
 \* DECREASE

Press  (INCREASE) or  (DECREASE) repeatedly to scroll through the available channel names for an appropriate choice. Choices for channel names are: CH1, CH2, CH3, CH4, LOAD1, LOAD2, LOAD3, LOAD4, DISP1, DISP2, DISP3, DISP4, FLOW, STAB, PRES1, PRES2, PRES3, PRES4, VOLU1, VOLU2, VOLU3 and VOLU4.

**NOTE:** It is important to assign an appropriate name when naming channels because the HM-2750 Series controller will choose a unit of measure based on the name assigned. For example, if you are configuring a load cell, name the channel Load 1, 2, 3 or 4. This will ensure that the channel reads in lbs (kN). The same applies to Displacement (DISP 1, 2, 3 or 4) reading in in/mm and Pressure (PRES1, 2, 3 or 4) reading in psi (kPa).

Once a name has been chosen for a channel Press  to return to the previous screen. You should see this screen:  
 (LOAD1 was chosen as name):

“CH1” CONFIGURATION  
 \* NAME = “LOAD1”  
 \* ENG MIN = 0  
 \* ENG MAX = “VALUE”

**Set Min**





The Engineering Zero (ENG MIN) is not configurable and is set at 0.

**Set Max**

Press  (ENG MAX) to set the Engineering Maximum value.

You should see this screen:

“CH1” MAX SETUP  
 \* ENG MAX = “000000”  
 \* INCREASE  
 \* DECREASE

Press  (ENG MAX) to move between the numbers. Keep pressing  until the digit you want to change is flashing. Once you have selected the number you want to change, press  (INCREASE) or  (DECREASE) to change the number to the desired value. Below is a configuration chart for Humboldt instrumentation. These are the numbers that correspond to each Humboldt device.

Load Cell	Part#	Eng Max (lbf)	Metric Max (kN)
10,000 lb. (50kN)	HM-2300.100	010000	050.00
5,000 lb. (25kN)	HM-2300.050	005000	025.00
2,000 lb. (10kN)	HM-2300.020	2000.0	10.000
1,000 lb. (5kN)	HM-2300.010	1000.0	05.000
500 lb. (2.5kN)	HM-2300.005	0500.0	02.500
LVDT Transducer	Part#	Eng Max (in.)	Metric Max (mm)
0.4" (10.0mm)	HM-2310.04	0.4000	10.000
1.0" (25.4mm)	HM-2310.10	01.000	25.000
2.0" (50.8mm)	HM-2310.20	02.000	50.000
Pore Pressure	Part#	Eng Max (psi)	Metric Max (kPa)
100psi (1000kPa)	HM-4170	0100.0	001000

To return to any prior screen you can always press .

## Channel Test Configuration (Models A and D only)

In order to perform a test, channels must be configured for the specific test you wish to run. To configure a channel for a test, press . You should see this screen:

\* REVIEW LAST TEST  
 \* RUN TEST  
 \* ENGINEERING SETUP  
 \* SET DATE/TIME/UNITS/STND

Press  (ENGINEERING SETUP). You should see this screen:

\* CONFIGURATION  
 \* CALIBRATION  
 \* SAMPLING INTERVAL  
 \* MANUFACTURES INFO

Press  (CONFIGURATION) You will be asked for a password, enter:















You should see this screen:

CONFIGURATION SCREEN  
 \* SELECT CHANNEL "CH1"  
 \* CONFIGURE CHANNEL  
 \* CONFIGURE TEST

Press  (SELECT CHANNEL) to scroll through and choose the channel you wish to calibrate. Once you have selected a channel press  (CONFIGURE TEST). You should see this screen:

\* DIRECT SHEAR TEST "N"

To assign a test to the selected channel, press the corresponding function key to the test you wish to select. For the HM-2750 Controller you will want to choose DIRECT SHEAR TEST, so press  (DIRECT SHEAR TEST) to assign that test to the channel you have chosen. Pressing a key will toggle between "Y" and "N". For example, press  to choose DIRECT SHEAR TEST, which will change the "N" to a "Y" next to DIRECT SHEAR TEST,. This would indicate that the channel selected would be set up to run Direct Shear Tests.

## Calibration (Models A and D only)

This menu item is used to calibrate or verify the calibration of the HM-2750. NOTE: The HM-2750 and instrumentation is usually calibrated at the factory

**WARNING: Calibration should only be performed by trained personnel with proper, certified equipment. The HM-2750 and its instrumentation should be calibrated once a year.**

### Channel Calibration

To calibrate a channel, press  You should see this screen:

\* REVIEW LAST TEST  
 \* RUN TEST  
 \* ENGINEERING SETUP  
 \* SET DATE/TIME/UNITS/STND

Press  (ENGINEERING SETUP). You should see this screen:

\* CONFIGURATION  
 \* CALIBRATION  
 \* SAMPLING INTERVAL  
 \* MANUFACTURES INFO

Press  (CALIBRATION) You will be asked for a password, enter:



You should see this screen:

CALIBRATION SCREEN  
 \* SELECT CHANNEL "CH1"  
 \* CALIBRATE CHANNEL  
 \* CLEAR CALIBRATION

Press (SELECT CHANNEL) to scroll through and choose the channel you wish to calibrate. Once you have chosen the desired channel you wish to calibrate press (CLEAR CALIBRATION).

**WARNING: IF YOU CLEAR A CALIBRATION IT IS LOST FOREVER!**

After the calibration has been cleared, Press (CALIBRATE CHANNEL) You should see this screen:

"CH1" CALIBRATION  
 \* SET GAIN  
 \* SET MIN  
 \* SET MAX

Press (SET GAIN). With the instrument you wish to calibrate mounted to a calibration frame attached to the HM-3000, record the division min value with no load on the instrument (X divisions).

Next, apply the full engineering load value to instrument on the calibration frame and again, record the division min reading (X divisions). Subtract the two values. This value should be a number larger than the maximum rating of the instrument.



If not, you need to increase the gain to compensate for the difference. Press

(SET GAIN) and repeat until the difference between the two values is more than the maximum rating of the instrument.



**EXAMPLE:**

If you are calibrating a 10,000 lb. load cell, you need a difference value of at least 10,000 divisions. If you register a min value reading of 450 divisions with no load on the instrument and your min is 8450 divisions at full load on the instrument, your difference value will be 8000 divisions. ( $8450 - 450 = 8000$ ). To increase the gain press  (SET GAIN) until you have more than 10,000 divisions.

Once the gain has been set, the zero point needs to be set. To set the zero point, apply the 0% force to the instrument and press  (SET MIN). Next apply the 100% force to the instrument and press  (SET MAX).

To return to any prior screen you can always press .

On the next page is an Instrumentation calibration chart listing max divisions, as well as typical gain factors needed in calibrating each instrument type.

**Humboldt Calibration Instrumentation Chart**

Load Cell	Part#	English (divisions)	Gain	Metric (divisions)	Gain
10,000 lb. (50kN)	HM-2300.100	10000	4	5000	4
5,000 lb. (25kN)	HM-2300.050	5000	2	2500	4
2,000 lb. (10kN)	HM-2300.020	20000	8	10000	4
1,000 lb. (5kN)	HM-2300.010	10000	4	5000	4
500 lb. (2.5kN)	HM-2300.005	5000	4	2500	4
<b>LVDT Transducer</b>					
0.4" (10.0mm)	HM-2310.04	4000	2	10000	2
1.0" (25.4mm)	HM-2310.10	1000	1	25000	2
2.0" (50.8mm)	HM-2310.20	2000	1	50000	4
<b>Pore Pressure</b>					
100psi (1000kPa)	HM-4170	1000	1	1000	1

## Standard Direct Shear Test

Press  (SET UP) You should see this screen:





\* REVIEW LAST TEST  
\* RUN TEST  
\* ENGINEERING SETUP  
\* SET DATE/TIME/UNITS/STND

Press  (RUN TEST) You should see this screen:

\* DIRECT SHEAR TEST

Press  (NEXT). You should see this screen:

MOTOR SPEED ADJUST  
\* SPEED = "X.XXXX"  
\* INCREASE  
\* DECREASE

Press  (SPEED) to move between the numbers. Keep pressing  until the digit you want to change is flashing. Once you have selected the number you want to change, press  (INCREASE) or  (DECREASE) to change the number to the desired value.

Once you have set the speed, press  to start the test.  
You should see this screen:

DIRECT SHEAR TEST# of readings	
LOAD 1	“#”
DISP 1	“#”
DISP 1	“#”

The display will show the current reading of the load. At any time you can press  (END TEST) to end the test. This will stop the data collection and reverse the machine back.

Once the sample makes contact with the box, the machine will automatically zero the load and collect a load reading every “X” sec. depending on what the sampling interval is set at (see Sampling Interval). Once the load cell has reached its peak load and fallen 2%, the machine will stop collecting data and reverse the platen back to the lower limit at the fast rate (0.5 in/min). The peak load will be displayed.



You should see this screen:

* REVIEW DATA
* RUN DIRECT SHEAR TEST

The peak values are shown on the first two lines. You can then review the data by pressing  (REVIEW DATA).

You should see this screen:

* PRINT DATA
* SCROLL DATA
* RUN DIRECT SHEAR TEST



Pressing  (PRINT DATA) will print the data either to a printer or a computer. Once you have printed the data you can run another test by just pressing  (RUN DIRECT SHEAR TEST). However you need to load another before you press .

If you don't have a printer or computer connected to the frame, you can press  (SCROLL DATA) to scroll the data.

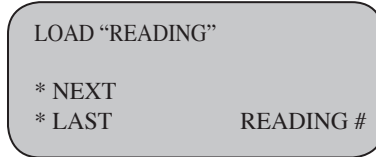
You should see this screen:



LOAD "READING"  
\* NEXT  
\* LAST                      READING #

You can then press  (NEXT) to see the next reading or  (LAST) to see the last reading.

To return to any prior screen you can always press .

## Software

Humboldt's HM-2750 Series Controllers come with Humboldt's HMTS data collection software. This software can be used to collect data from tests by creating user-defined test parameters (start/stop). The resulting data can then be opened in Microsoft Excel to view the data collected, as well as create a simple table and graph.

Optional pre-defined reporting software modules and templates are available for specific tests, such as CBR, Triaxial, etc. These modules provide more control over start and stop conditions for specific tests, as well as provide extended reporting capabilities. Contact Humboldt for more information.

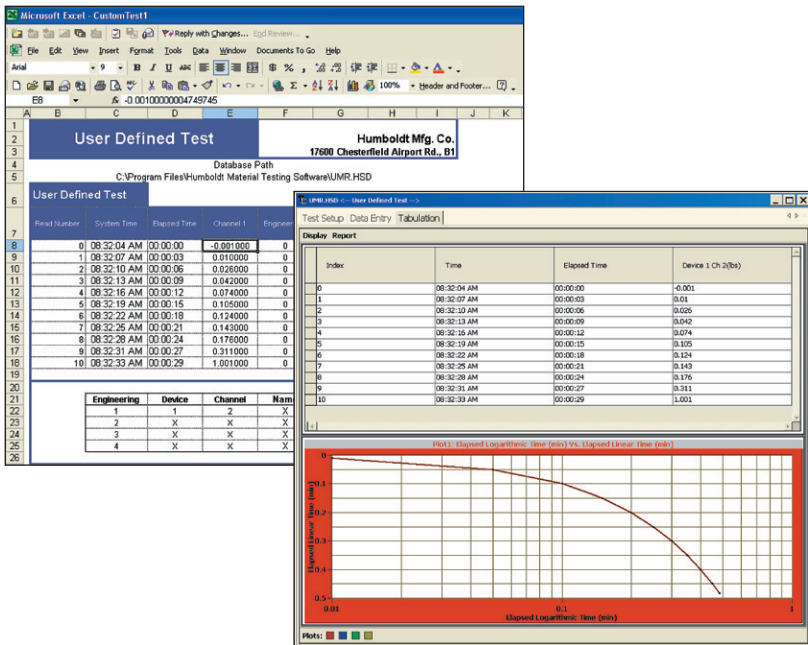

Table/graph and Excel output of user-defined test generated from software included.

The minimum compatible computer configuration is a PC with Pentium III 550 MHz processor, 512 MB of RAM and a 40GB hard drive running Windows® XP Professional system software.

## Specifications

### Mechanical Specifications

Dimensions (l x w x h)	8.3 x 9.5 x 4.7 inch (210 x 240 x 120mm)
Shipping Weight	6 lbs. (2.7Kg)

### Electrical /Electronics Specifications

Voltage	110/220 VAC 50/60HZ
Data storage	300 Readings/Channel
Computer port	RS232

## Support

Phone support is available for general operating questions and trouble shooting problems between 8am and 5pm Eastern Time. Please call:

**1.800.537.4183**

1.919.832.6509 or fax: 1.919.833.5283

support@humboldtmg.com

For sales and sales-related information, such as available accessories, general sales questions, pricing, please call:

**1.800.544.7220**

1.708.456.6300 or fax: 1.708.456.0137

hmc@humboldtmg.com

## Hidden Functions

The following are functions that are possible if needed, to access them, please contact support at the numbers or email address listed above.

### 1. System reset

Reset available in case of serious problem in system memory. This will cancel all data in memory calibration/configuration of all channels.

### 2. System restore

Restore to be made in case of above. This will restore all factory calibration/configuration of channels to their full scale.

### 3. System raw data

Raw data of analog to digital converter can be viewed to determine if instrumentation connected is functioning correctly.

## Hanger Assembly

ADJUST THE HANGER ASSEMBLY AS NECESSARY TO APPLY A COUNTER FORCE FOR THE PURPOSE OF COUNTERACTING THE WEIGHT OF THE SHEAR BOX TOP HALF.

ADJUST THE HANGER ASSEMBLY BY THE FOLLOWING:

1. Coarse adjustment is accomplished by raising or lowering the support hook assembly. To do so, loosen the thumbscrew on the support hook and adjust the position of the hook. Tighten the thumbscrew again to secure the support hook.
2. Fine adjustment is accomplished by loosening the nuts that secure either of the hooks on the hanger bar and adjusting the hooks up or down. When the adjustment is complete, tighten the nuts to secure the hooks.

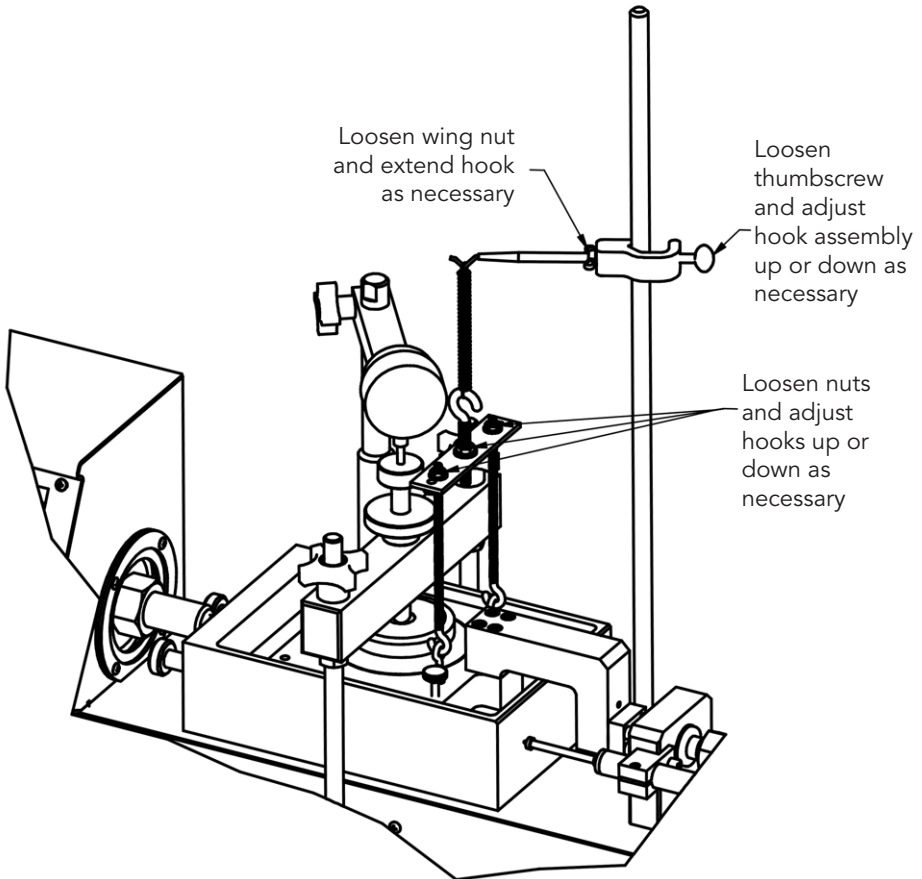



**Humboldt Mfg. Co.**

875 Tollgate Road  
Elgin, Illinois 60123 U.S.A.

U.S.A. Toll Free: 1.800.544.7220

Voice: 1.708.456.6300

Fax: 1.708.456.0137

Email: [hmc@humboldtmfg.com](mailto:hmc@humboldtmfg.com)

Testing Equipment for



Construction Materials

**HUMBOLDT**

[www.humboldtmfg.com](http://www.humboldtmfg.com)