



Erosion Function Apparatus

HM-5940 Erosion Function Apparatus

WARNING!

ENSURE WATER LEVEL IS ABOVE THE INTAKE FILTER BEFORE OPERATING PUMP. THE MECHANICAL SEALS IN THE PUMP REQUIRE THE CONSTANT FLOW OF WATER FOR COOLING AND LUBRICATION, AND WILL BE DAMAGED IF THERE IS NOT SUFFICIENT FLOW OF WATER IS AVAILABLE WHEN OPERATING

Specifications

Dimensions:

Length: 1.01 m

Width: 2.4 m (including wheel jacks)

Height: 2.4 m

(with outlet pipe erected and wheels retracted)

Weight

Empty: 1300 lb or 590 kg

Fully Loaded: 3000 lb or 1400kg

Pump

Model No: 25SH06D15T3F2

Volt: 208-230 VAC

Amp: 34-36.8

Peak Amps Required: 40 Amps

Horsepower: 15

HZ: 60

Maximum Ambient Temperature: 40C

Water Velocity

0.3 m/s to 6.0 m/s

Installation

Assembly

The Humboldt HM-5940 EFA requires some assembly upon arrival. The outlet pipe section is shipped with the machine and must be attached once the machine is positioned in the laboratory.

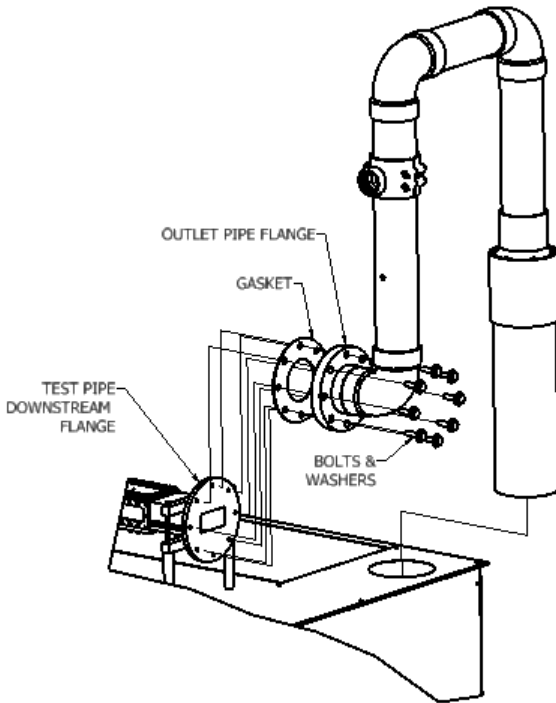

Fig. 1: Humboldt HM-5940 Outlet Pipe Assembly

Each of the holes in the PVC plastic pipe flange are numbered. Use these numbers for the bolt tightening sequence.

Water

One tap water wall-mounted outlet should be permanently connected to an inlet water hose which is also connected to the inlet water valve. The Humboldt HM-5940 EFA machine comes supplied with a female garden hose fitting on the inlet water valve. The inlet hose fitting is a $\frac{3}{4}$ inch garden hose connector fitting.

Drainage

A floor drain or sewage port is needed near the EFA to facilitate periodically draining the water tank. It is suggested that a permanent drainage hose go into the drain. The HM-5940 EFA machine has two water outlet connections. The upper connection has a $\frac{3}{4}$ inch garden hose fitting which is connected to the pipe coming from the sump pump in the bottom of the tank. The second outlet is located at the bottom of the low end of the tank. The lower outlet has a valve with a $\frac{3}{4}$ inch NPT female thread.

Power

The Humboldt HM-5940 EFA machine requires 230 volt, 3-phase, 60 Hz, wall-mounted service. A 5 wire power cord (3 phase, neutral, ground) is supplied with the machine.

Ceiling/Door Height

If the EFA is to be placed in a room, check the door height as well as the ceiling height to be greater than the height of EFA. A minimum height of 2.5 m (≥ 8 feet) is required with the wheels fully retracted.

Weight

The Humboldt HM-5940 EFA weighs approximately 5.8kN (1300 lbs). One fully loaded EFA weighs at least 13.3kN (3000 lbs). There is also a slight dynamic load factor when the pump is working. Be sure to check the floor load grade before moving in the EFA into position.

Ventilation

The room for the EFA should be well ventilated.

Illumination

The room for the EFA should be well illuminated.

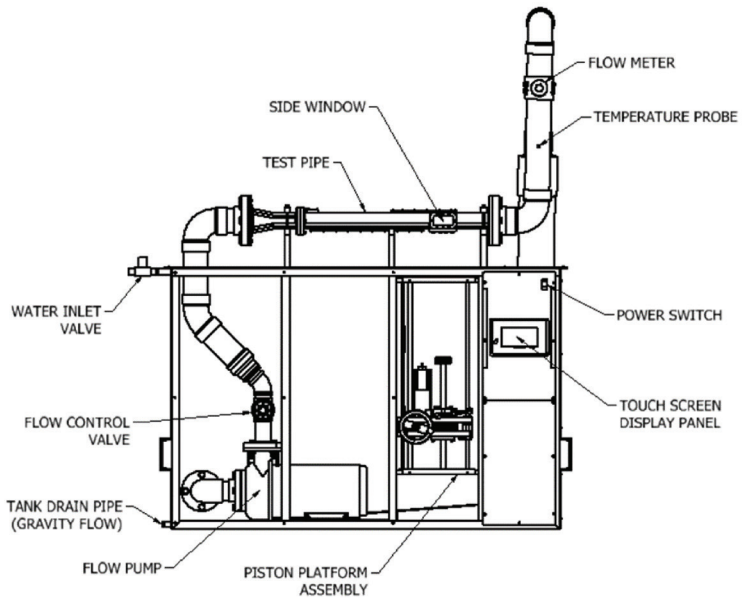

Figure 2: Elevation View of EFA

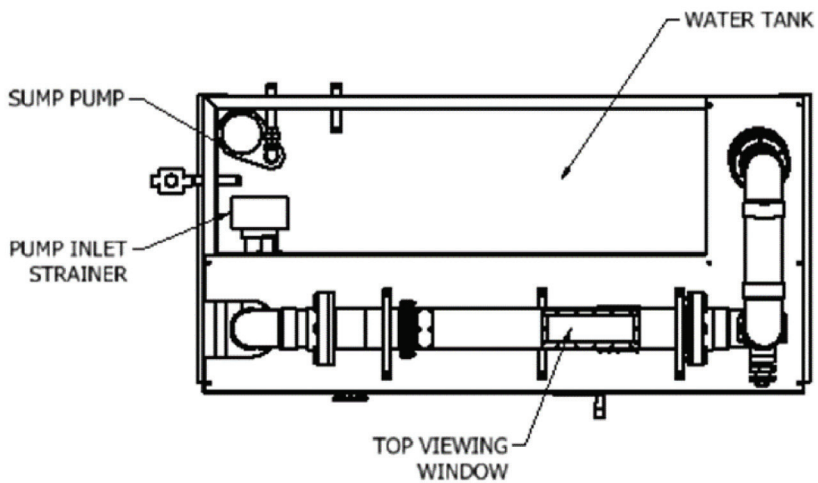

Figure 3: Plan View of EFA

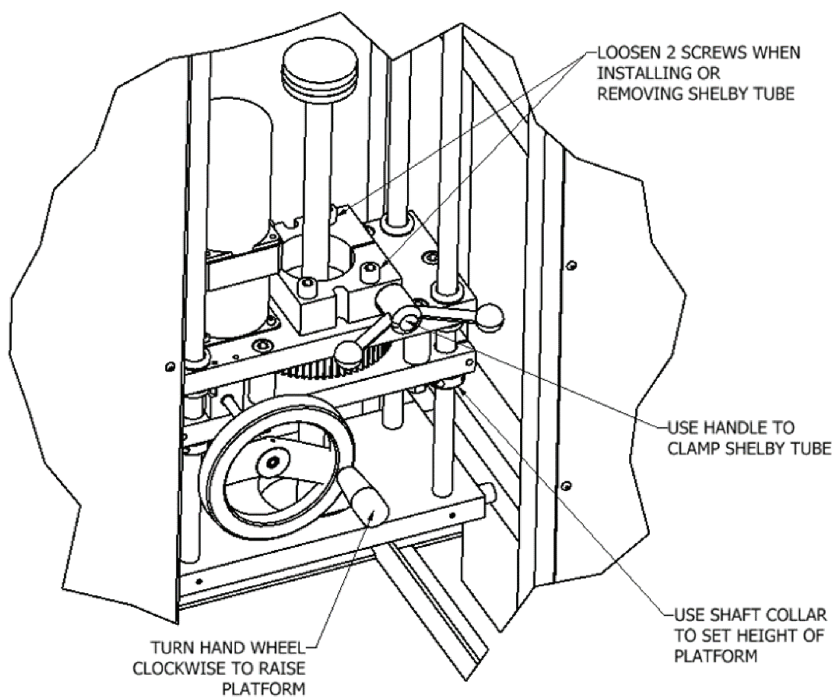

Figure 4: Detail View of Sample Compartment and Function of Components Within

EFA COMPONENT DESCRIPTION

1. Flowmeter

- a. The hardware monitors the speed of the water using the flowmeter downstream of the sample. The dimensions of the PVC up-pipe are used to determine a flow rate which is then used to determine the flow speed across the sample.

2. Temperature Probe

- a. The resistance of the thermistor is monitored in order to display and record temperature.

3. Water Level Sensor

- a. Two water level sensors are used to ensure the tank is not under- or over-filled.

4. Water Control

a. If fresh water is not cycled through the machine the pump will slowly heat up the water over time. As such, during testing we recommend turning on all three buttons (Sump, Flow, and Fill) to keep temperatures relatively constant. The water will sump to the bottom sensor, fill to the top sensor, then repeat. When the Flow Pump is turned off, if the Sump Pump button is on, the machine will continue to sump all water out of the tank.

- b. A complete description of the possible states of the system are as follows:

- i. Fill **OFF**, Flow **OFF**, Sump **OFF**

1. System will do nothing.

- ii. Fill **OFF**, Flow **OFF**, Sump **ON**

2. System will sump all water out of the tank.

WARNING: There is no automatic shut off of the sump pump. User must manually turn off the sump pump when water level gets lower than sump pump intake.

- iii. Fill **OFF**, Flow **ON**, Sump **OFF**

1. System will flow water through the machine only.

- iv. Fill **OFF**, Flow **ON**, Sump **ON**

1. System will flow water through the machine and will sump water out until no water is seen at the lower water level sensor. Once water is no longer detected the sump pump will stop but the water flow will continue.

- v. Fill **ON**, Flow **OFF**, Sump **OFF**

1. System will fill water tank until water is detected at upper water level sensor.

vi. Fill **ON**, Flow **OFF**, Sump **ON**

1. System will begin filling water and pumping water out at the same time. **WARNING:** In this case the sump pump will not turn off and will continue to pump out water if the water level gets below the lower water level sensor.
2. This setting should not be used for anything other than recycling all water out of the tank and refilling with fresh water. However, the user will need to manually turn off the sump pump.

vii. Fill **ON**, Flow **ON**, Sump **OFF**

1. System will flow water through the machine and will fill the water tank until water is detected at the upper water level sensor. Once water is detected the filling will stop but water flow will continue.

viii. Fill **ON**, Flow **ON**, Sump **ON**

(Recommended setting during testing).

1. System will fully automate water cycling. Water will flow over the sample continuously. At the same time, water will be pumped out of the tank until no longer detected on the lower water level sensor. At this point the sump will turn off and the water tank will fill up until water is detected at the upper level sensor. The sump will then re-activate, starting the cycle anew.

Touchscreen Operation

Main Screen:

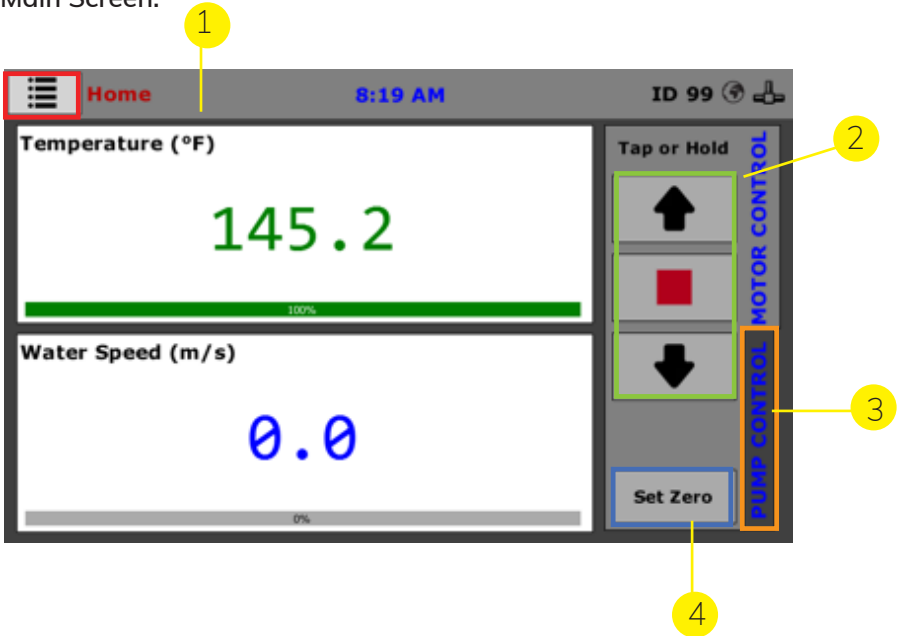

1. **Menu:** Press to access current and previous test screens and settings.
2. **Shelby tube motor controls:** Tap a button to move piston slightly; hold to move quickly.
3. **Pump Control tab:** Press to access water controls.
4. **Zero: Press to reset:** "Push Distance" variable (Used prior to testing).

Pump Controls:

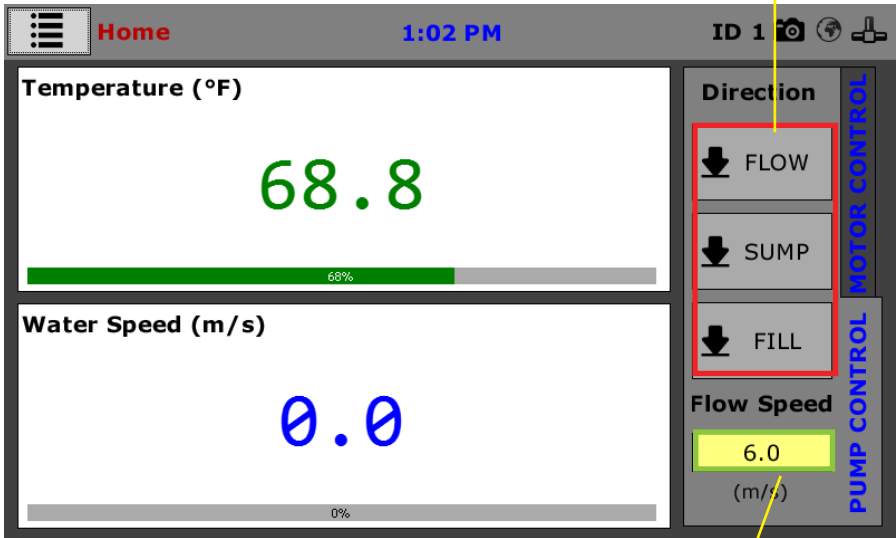

1. Water control buttons:

- FLOW turns the pump motor on and off
- SUMP turns the sump pump on and off
- FILL opens and closes the fill valve

2. **Flow speed:** Tap the yellow box to enter a new flow speed (flow units can be changed in Settings->Preferences)

Current Tests:

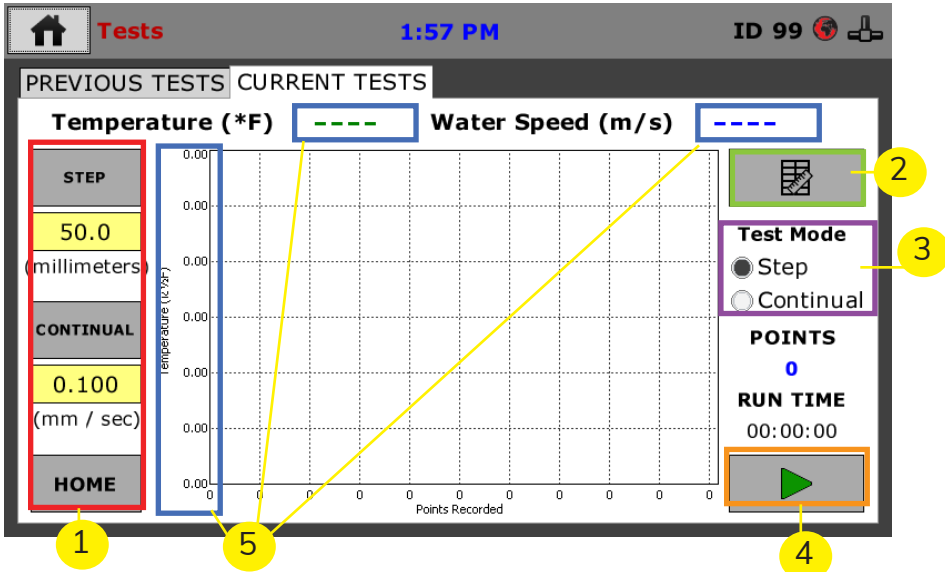

1. Shelby Tube Controls:

- The STEP button will push the soil sample up by the distance indicated in the yellow box under the STEP. The push speed is indicated in the yellow box under the CONTINUAL button
- The CONTINUAL button will continuously push the soil sample up at the speed indicated in the yellow box under CONTINUAL
- The HOME button will return the piston to the bottom of the tube
- Tap the yellow box to change the push distance

2. **Table/Graph Button:** Press to switch between graph and tabulated views.

3. **Test Mode Selection:** Select how to operate the piston during a test.

4. **Start/Stop Button:** Press to start or stop recording data.

5. **Graph Selection:** The graph can be cycled between water temperature and flow speed by graph label on the Y axis (4). This operation can be done on either a previous test or a current test.

Previous Tests:

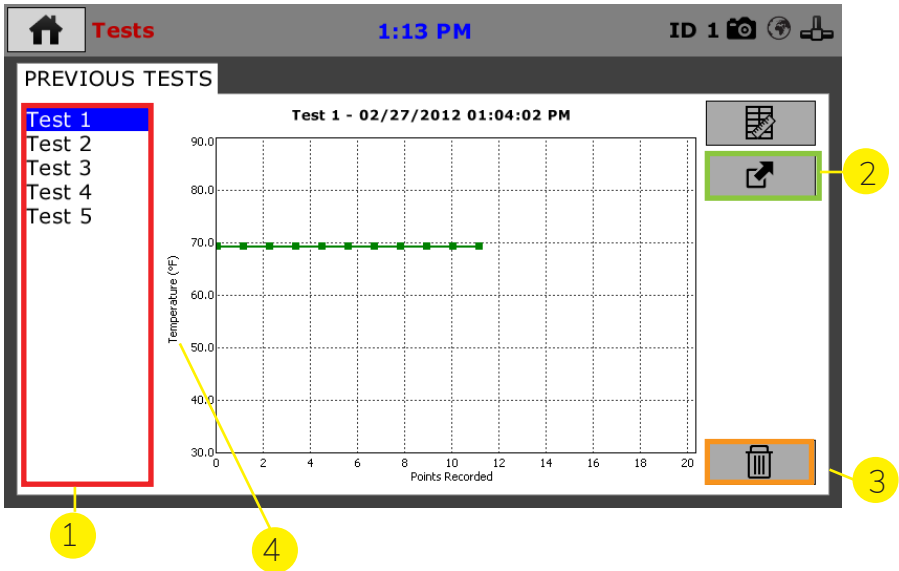

1. **Test selection:** The most recent test is Test 1; select other entries to show previous tests.
2. **Export:** Press to export the test to a USB stick. This will export as an .HTD file. This file can be uploaded to a PC to view using the HM Data Download software.
3. **Delete:** Press to delete test from internal storage.
4. **Graph Selection:** Press to toggle between the Temperature and Flow Speed graphs

Settings:

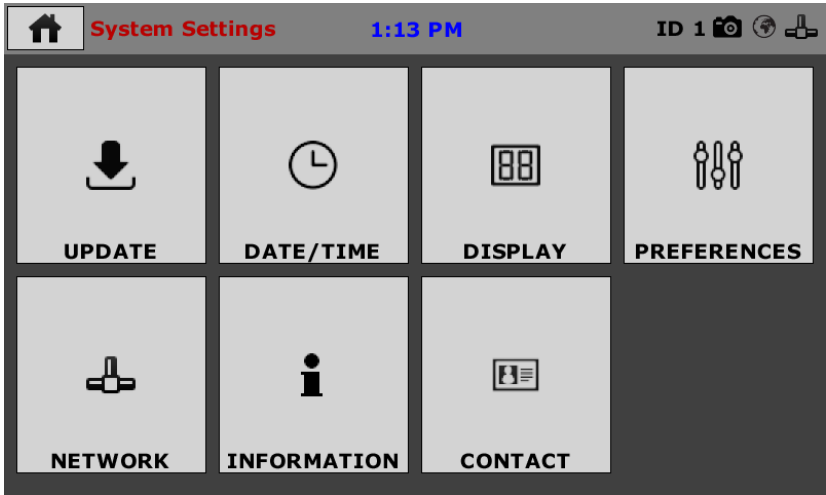

Update: Provides the ability to update the controller from the USB stick.

Date/Time: Set the clock and related options.

Display: Adjust the backlight and automatic dimmer.

Preferences: General settings (units, controls etc.)

Network: DHCP toggle and static IP settings.

Information: General machine info often requested for support purposes.

Contact: Humboldt contact info.

Adjusting Flow Speed

The screenshot shows a control interface with a top status bar containing a menu icon, the word "Home", the time "1:02 PM", and the text "ID 1" with camera, location, and printer icons. The main area is divided into two large panels. The top panel, titled "Temperature (°F)", displays "68.8" in green and a green progress bar at 68%. The bottom panel, titled "Water Speed (m/s)", displays "0.0" in blue and a grey progress bar at 0%. To the right is a vertical sidebar with a "MOTOR CONTROL" label. It contains three buttons: "FLOW", "SUMP", and "FILL", each with a downward arrow icon. Below these is a "Flow Speed" control box, which is highlighted with a red border. This box shows "6.0" in a yellow field and "(m/s)" below it. At the bottom of the sidebar is a "PUMP CONTROL" label.

The flow speed box controls the velocity of the circulating water in the machine. The machine can operate up to 7.0 m/s. (Note: To achieve speeds higher than 6.0 m/s it is recommended to use a power supply that can output up to 40 A.)

Flow Controls:

Pump Modes of Operation:

The main water pump has three options for controlling the velocity of water flowing over the sample. Depending on the water flow speed desired; automatic, manual, or sump control may be chosen for managing the water velocity for the test.

Automatic Mode:

In Automatic Mode manages the water flow speed between the ranges of 0.20 m/s to 7.0 m/s. When in Automatic Mode, the controller will automatically monitor the water velocity and adjust the pump's water output to maintain the target water velocity. This the default control setting for the EFA, and nothing need be done in order to operate the EFA in Automatic Mode.

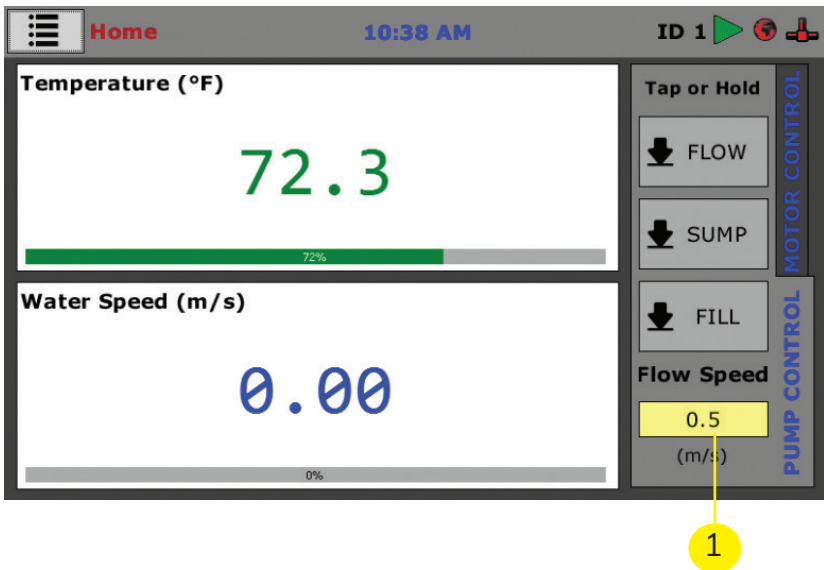

1. To use the Automatic Mode simply enter the desired water velocity on the touch screen and press the FLOW button.

Manual Mode:

Manual mode is intended for use where the desired water velocity is between 0.2 m/s – 7.0 m/s, and it is desired to manually fine tune the flow speed. To use the Manual Mode for water flow control, select HOME>SYSTEM SETTINGS>PREFERENCES on the control panel touch screen.

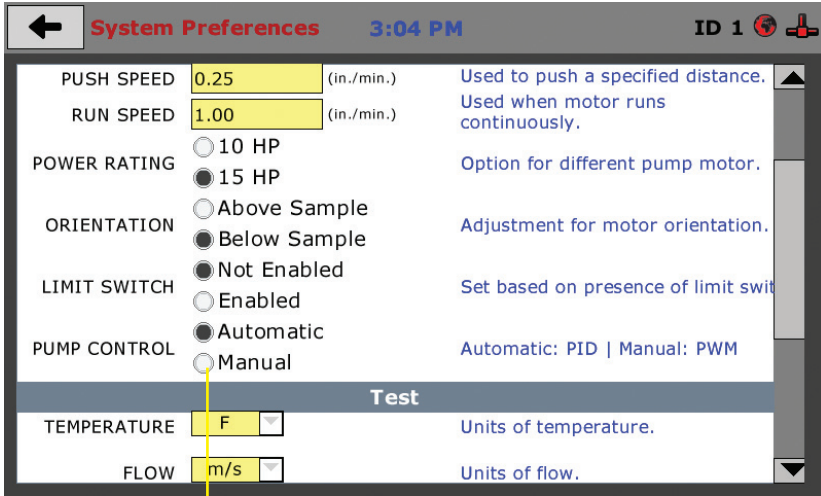

1. Once in the PREFERENCES window, scroll down using the slide bar on the touch screen and select the MANUAL radio button.

Ensure to open the Flow Restriction valve on the front of the EFA before pressing the Flow button on the touch screen. After water starts flowing for 15 seconds the flow rate should stabilize and the Flow Restriction valve can be adjusted to fine tune the flow rate to the desired target.

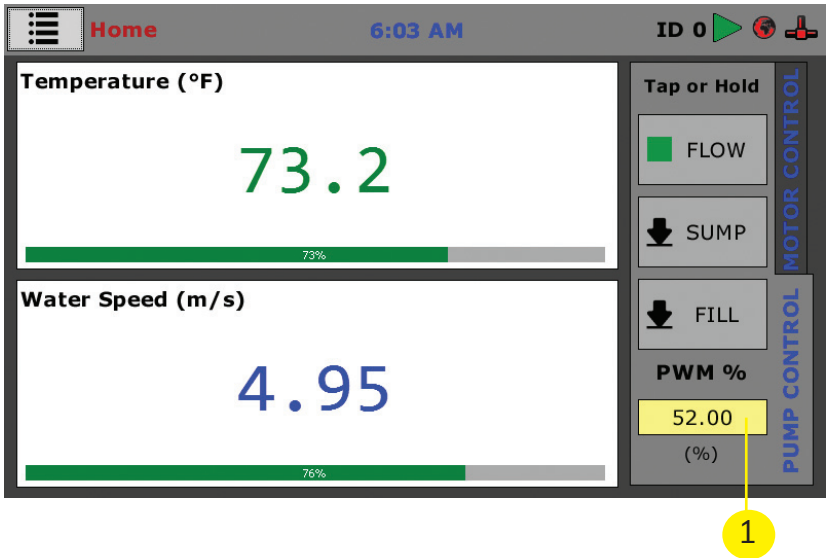

1. When the control is set to Manual Mode the pump output is displayed as a percent value. The default value is set at 20% and has a range of 14% - 100%.

NOTE: UK models have a PWM range of 13.3% - 100%.

Sump Flow Control:

Sump Flow Control is an alternate method of managing low a water velocity by using the sump pump rather than the primary water pump for water circulation. Much like the Manual Mode for the primary pump, using the sump pump to control the water velocity will also allow for flow speeds between 0.15 m/s and 0.2 m/s. However, using the sump pump to manage the water velocity requires the user to set the valves on the EFA prior to engaging the sump pump.

To use the sump pump to manage the water speed do the following:

1. Fully close the Flow Restriction valve



Flow Restriction Valve

1. Ensure the sump drain valve is closed (blue handle)

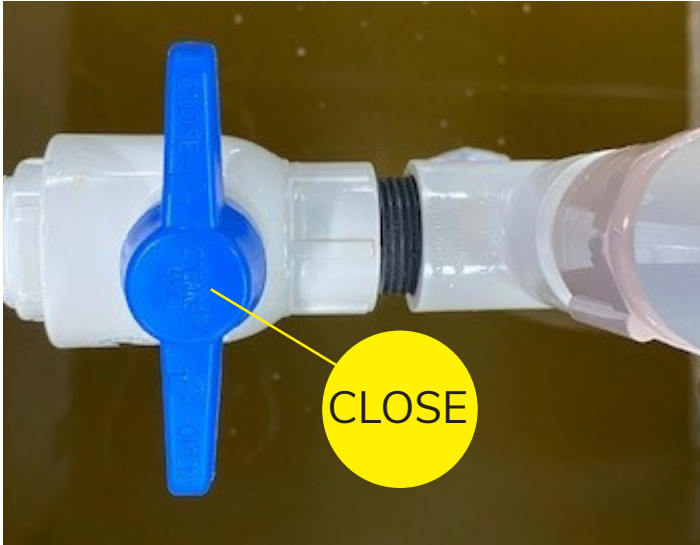

Sump Drain Valve (Closed)



Sump Drain Valve (Open)

2. Open the sump flow valve (red knob)

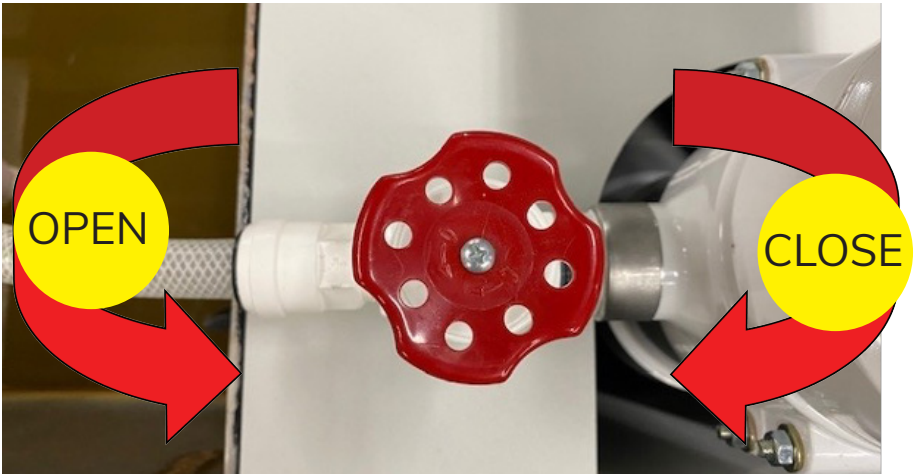

Sump Flow Valve

With the Flow Restriction valve closed and Sump Flow valve open, the water flow can be initiated by pressing the SUMP button on the touch screen. With the Sump Flow valve fully open, water will flow at 0.2 m/s. Once water is flowing over the sample and a water velocity is showing on the display, the Sump Flow valve can slowly be closed to reduce the water flow rate to the desired target rate.

NOTE: The flow meter can reliably read down to approximately 0.1m/s before its signal becomes unreliable and the accuracy of the displayed flow rate shown on the touch screen becomes less accurate.

Restricted Flow Control Valve:

The manual control valve is used to fine tune the flow speed of water when operating at low speeds (velocities less than 1.0 m/sec).

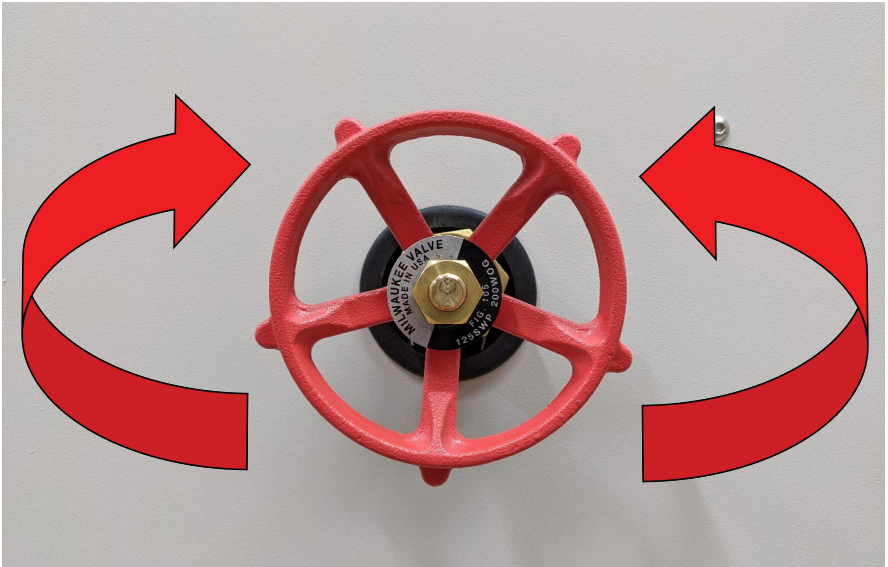

a. Opening Valve

- i. Turn the valve counterclockwise. Promotes water flow.

b. Close Valve

- i. Turn the valve clockwise. Inhibits water flow.

1. 1.0 m/s – 7.0 m/s

- a. Simply tap the yellow box, input the desired speed, and tap the check mark to confirm. For best results, the valve must be completely open.

2. Less than 1.0 m/s

- a. Any inputted value less than 1.0 m/s will set the pump to initially circulate water at a speed between 1.0 m/s to 1.3 m/s. To drive the flow speed to the desired inputted value, the valve, shown above, must be used. Once the value is set and the circulating water has stabilized, partially close the valve to the desired flow speed. The machine will stabilize the flow speed to the inputted value. (Note: As the water velocity is reduced to below 0.3 m/s, the measured precision reduces. This is due to the limitations of the flow sensor versus the minimum capacity of the flow pump.)

Adjusting Piston Position

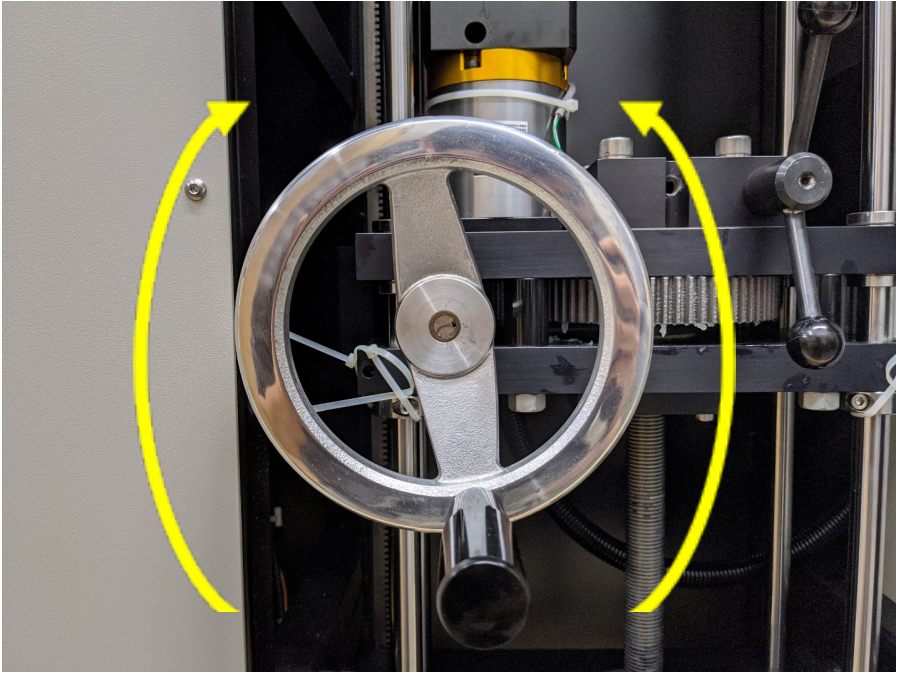

b. **Raising Piston**

- i. Turn the handle clockwise.

c. **Lowering Piston**

- i. Turn the handle counterclockwise.

Initial Set up— Date and Time

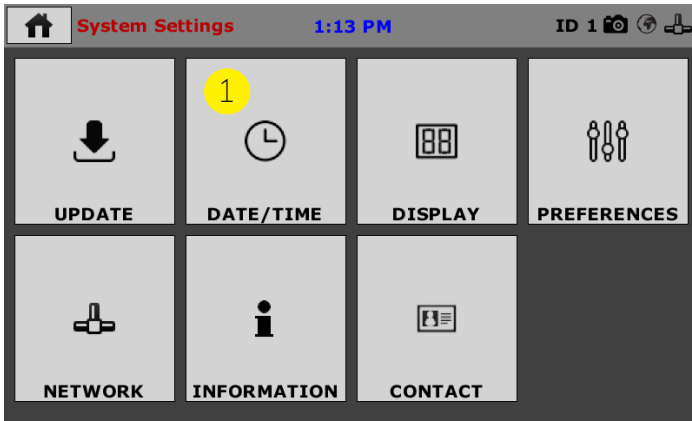

Click on the Date/Time tab (1). You will see the following screen.

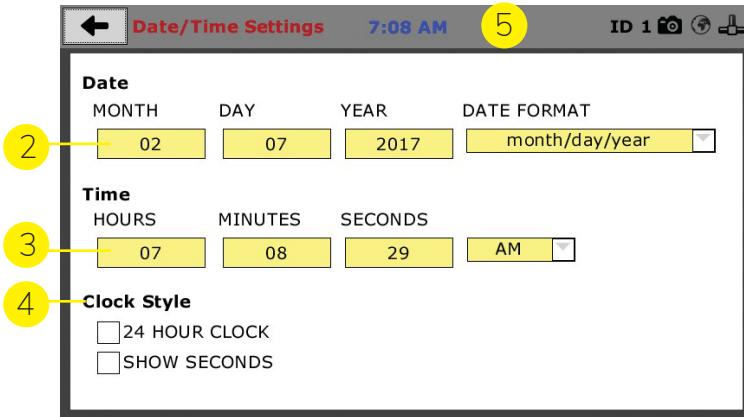

Date (2)

Set the month, day, year, and date display format.

Time (3)

Set the hours, minutes, seconds, and am/pm.

Clock Style (4)

Select a clock view, either a 24-hour or 12-hour clock, as well as the option to show seconds or not.

Clock (5)

The current time is displayed is located on every controller screen. Clicking on the time from any screen, you will be taken to the Date/Time Settings Screen.

Initial Set up— Display Settings

To set up Display settings, return to the System Settings screen and click on the Display Panel. (1)

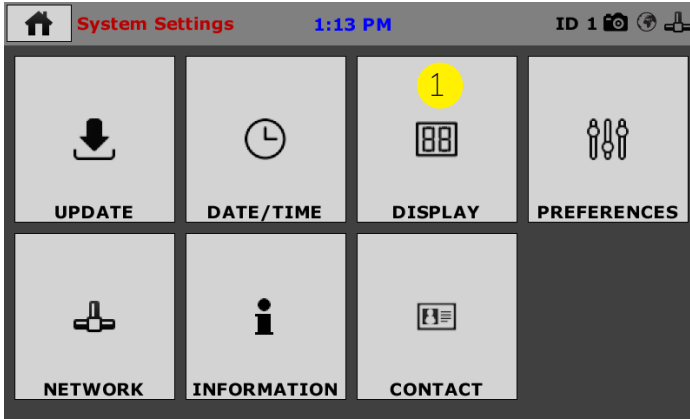

You will see the following screen.

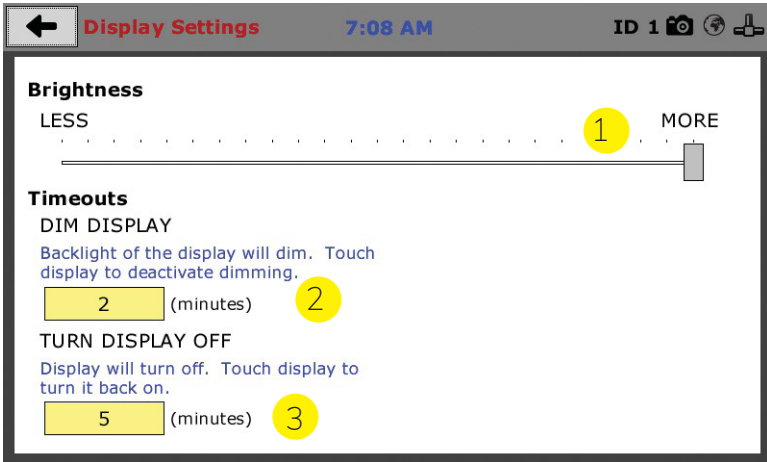

Brightness (1)

Slide the gray bar to the left or right to adjust brightness.

Dim Display (2)

The backlight of the display will automatically dim to save power. Click the yellow box to change the number of minutes before the display goes dim. After the time has elapsed, touch the display to deactivate dimming.

This screen is accessed by clicking on the “Preferences” button. (1)

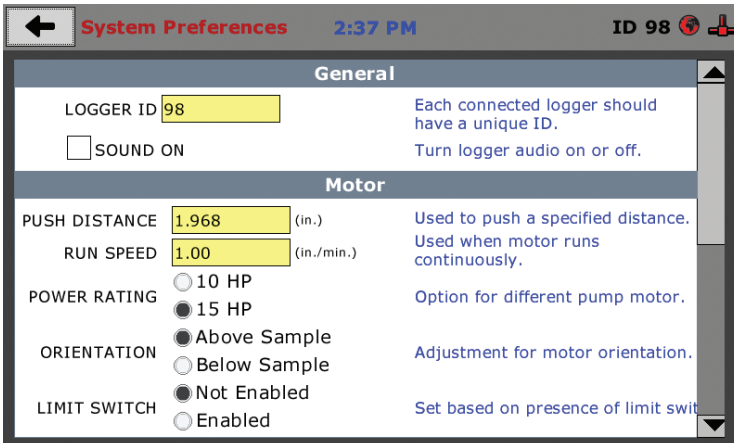
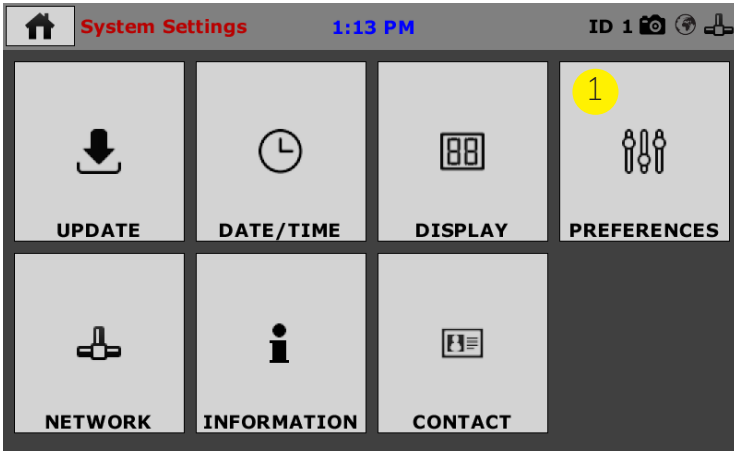

Logger ID

Each machine that is connected to your network requires a unique Logger ID. These numbers can be assigned any number between 1-245. Only one machine can be assigned a specific ID, If there are other Humboldt testing devices on the same Local Access Network, please ensure that each has its own unique ID number.

Sound

Checking this box enables or disables audio feedback for logger events. If the box remains unchecked, the machine will produce an audible beep each time a button is pressed.

Push Speed

The rate the sample will advance when a test is run under continual advance mode (see Test Controls on page 11).

Run Speed

This determines the water flow rate during a test. This value can also be changed on the Home page when preparing to run a test (see page 10, item 2)

Power Rating

This setting is dependent on the pump motor type installed and will not typically need to be adjusted. The default value is set at 15 hp.

Orientation

This is dependent on the version of the EFA produced. This will be set at the factory when the pump is initially installed and should not need to be adjusted by the end user.

Limit Switch

The limit switch prevents the sample extrusion piston from overextending and damaging the machine once the sample extrusion piston has reached its maximum extension. It is recommended that this setting remain in the factory default of ENABLED.

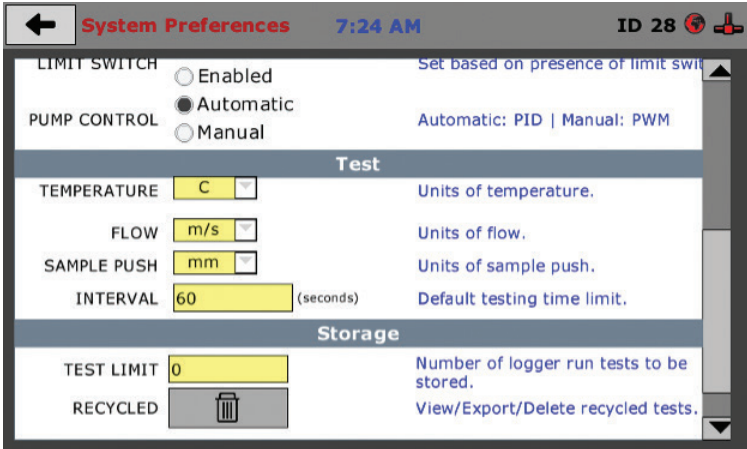

Pump Control

Determines what control method the test will be run, depending on the desired flow rate (see page 15-17 for details).

Temperature

Allows user to change between English and Metric temperature unit of measure.

Flow

Allows user to change units of measure for water flow rates (m/s, cm/s, in/s, or ft/s).

Sample Push

User can change units of measure for sample push distance (in, mm, or cm).

Interval

Time set for sample push intervals. This is only applicable when Test Mode is set to STEP.

Test Limit

Number of tests that are stored in active memory for review. Up to 50 tests can be stored in the active memory for review under Previous Tests.

Preferences – Storage Tab

This screen is accessed by clicking on the Storage Tab under System Preferences.

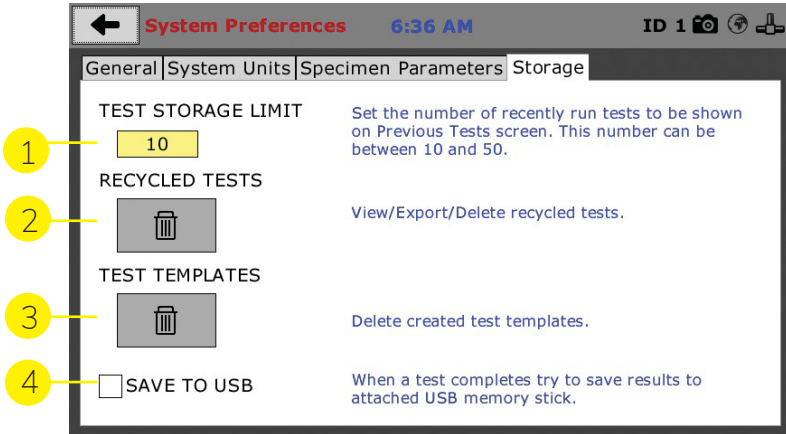

Test Storage Limit (1)

This field allows you to set the number of previously run tests to be available on the “Previous Tests” screen. This number can be between 10-50.

Recycled Tests (2)

This refers to previously run tests that are not displayed in the “Previous Tests” window. These tests are not deleted; they are recycled for later use. Select this button to view/ export/delete recycled tests.

Test Templates (3)

Select this button to delete test templates that have been created, but are no longer desired.

Save to USB Check Box (4)

Checking this Box saves the results of a test to USB thumb drive inserted into the front USB slot on the machine.

Initial Set up — Network

1. To set up Network settings, return to the System Settings screen and click on the Network panel.

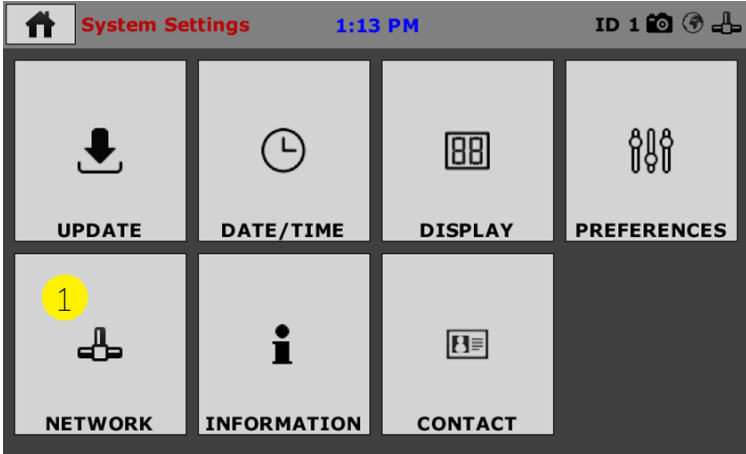

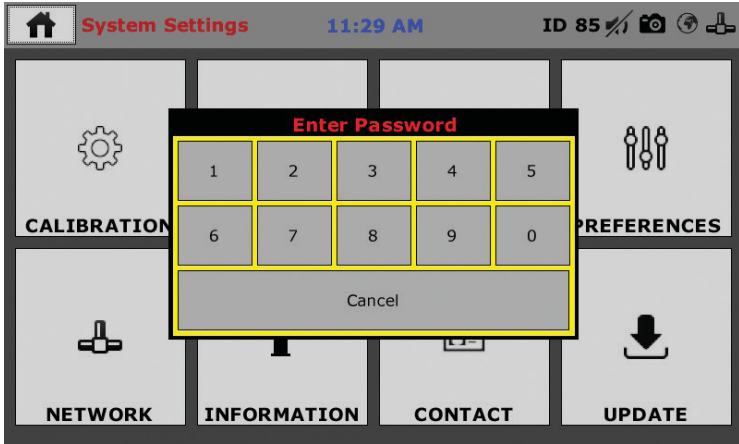

A password is required to access the Network Settings. That password is: 27604.

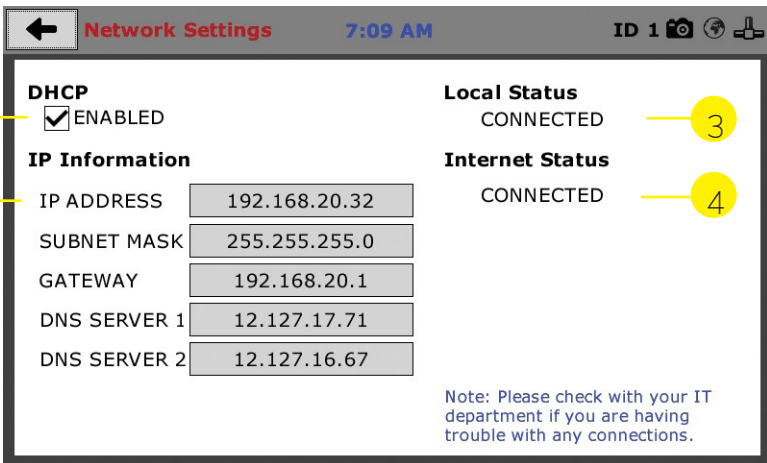

Network Settings Screen

The screen above is the Network Settings screen, it provides information on your IP information and network status.

DHCP (1)

Check this box to enable/disable the Dynamic Host Configuration Protocol (DHCP). If enabled, your machine will pick up IP information from your router. If disabled, you will need to manually enter the network information for a static IP, please consult your network administrator for this.

IP Information (2)

This information will be filled in automatically if the DHCP is checked, otherwise you will have to manually supply this information. The IP address must be unique for each machine.

Local Status (3)

This indicates the status of the local network connection, Connected or Disconnected.

Internet Status (4)

This indicates the status of your Internet connection, Connected or Disconnected.

Note: If you are experiencing issues with any connections, please contact your IT department for assistance.

Initial Set up— Information

Clicking on this panel provides a view of the current status of the machine. (1)

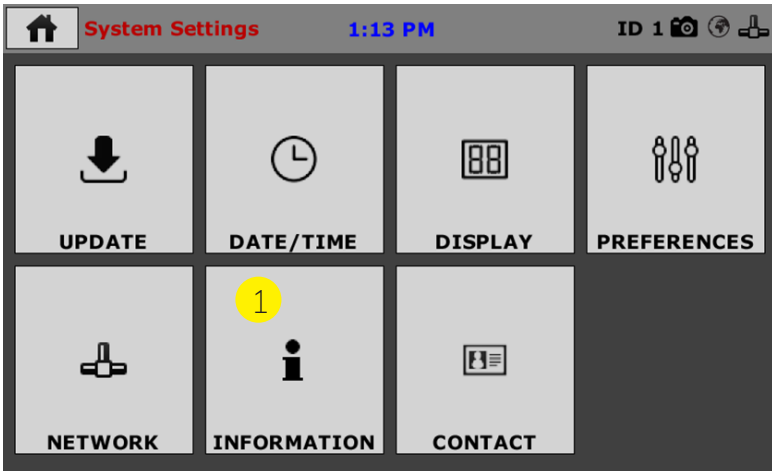

System Information

Below is a view of the System Information screen. It provides a current status of the machine.

The screenshot shows the 'System Information' screen with a title bar containing a back arrow, the text 'System Information', the time '7:09 AM', and icons for ID 1, camera, globe, and printer. The main content area is divided into several sections:

- Firmware Version (1):** 1.0.16 - B1.0.8 - CP1.1.2 - ADCv5
HM-5760 - GB 60.00 Standard
- IP Information (2):**

MAC ADDRESS	00:1e:c0:ad:ac:c6
IP ADDRESS	192.168.20.32
SUBNET MASK	255.255.255.0
GATEWAY	192.168.20.1
DNS SERVER 1	12.127.17.71
DNS SERVER 2	12.127.16.67
- Local Status (3):** CONNECTED
- Internet Status (4):** CONNECTED
- Memory (5):** 0.06 MB of 17.99 MB used
Note: Please check with your IT department if you are having trouble with any connections.
- Factory Screen (6):** A button with a document icon.
- Export Log File (7):** A button with a document and arrow icon.

Firmware Version (1)

The current version of the machine firmware is shown here. If you contact product support, you will need to supply this information.

IP Information (2)

This information will be filled in automatically if DHCP is checked, otherwise you will have to manually supply this information. The IP address must be unique for each machine.

Local Status (3)

This indicates the status of the local network connection, Connected or Disconnected.

Internet Status (4)

This indicates the status of your Internet connection, Connected or Disconnected.

Memory (5)

This indicates the current status of how much available memory is being used by the machine

Factory Screen (6)

This is for Humboldt use only.

Export Log File (7)

This button exports a log file from the machine to a USB thumb drive. Be sure to insert a thumb drive before exporting the file or you will receive an error. This file can be helpful in trouble shooting by

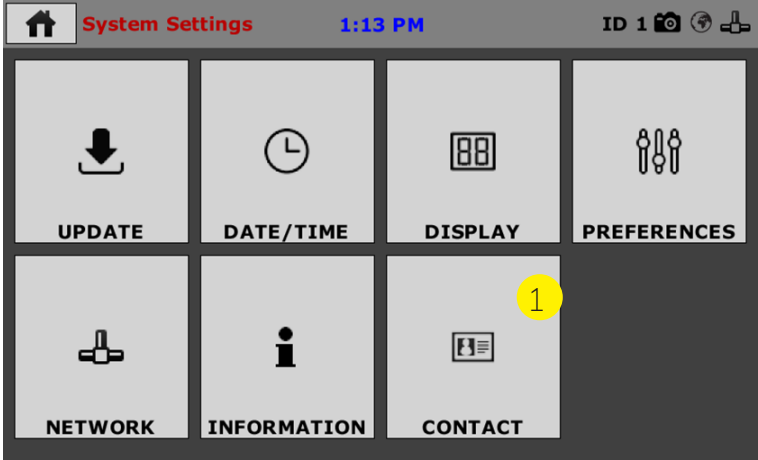

Initial Set up— Contact

1. Clicking on this panel provides contact information for Humboldt Support and Service.

Contact Information

Below is a view of the Contact Information screen showing contact information for Humboldt Support and Service.

For quickest response go to this link on our website: <https://www.humboldtmgf.com/support> and fill in the support form. This will provide us with the necessary information to assist you and you will be added to the next position in the support queue.

You can also email Humboldt Support at support@humboldtmgf.com or Humboldt Service at service@humboldtmgf.com. Please include contact information and a detailed description of your reason for contact.

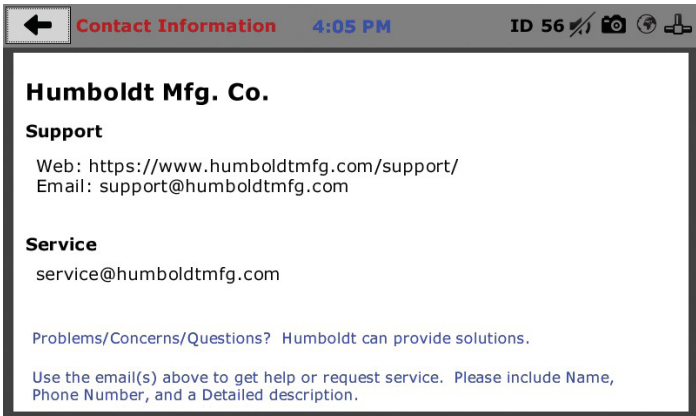

Initial Set up— Contact

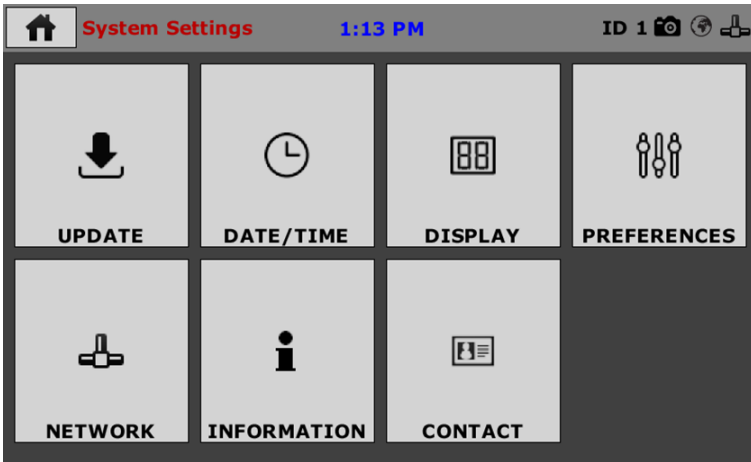

1. Clicking on this panel provides contact information for Humboldt Support and Service.

Contact Information

Below is a view of the Contact Information screen showing contact information for Humboldt Support and Service.

For quickest response go to this link on our website: <https://www.humboldtmfg.com/support> and fill in the support form. This will provide us with the necessary information to assist you and you will be added to the next position in the support queue.

You can also email Humboldt Support at support@humboldtmfg.com or Humboldt Service at service@humboldtmfg.com. Please include contact information and a detailed description of your reason for contact.

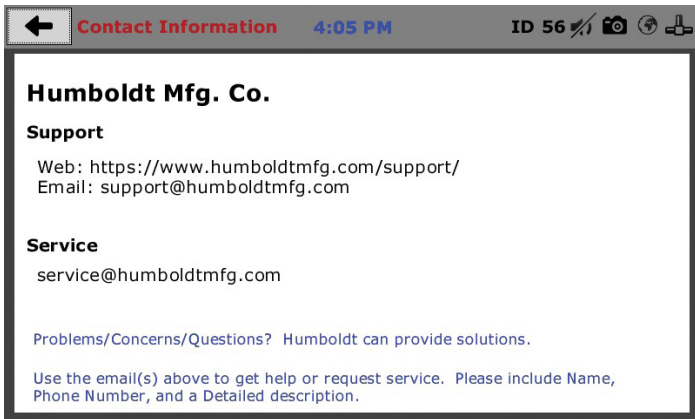

Initial Set up— Update

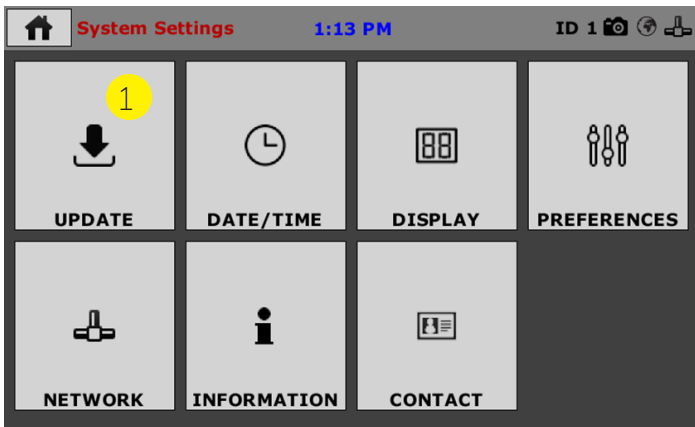

Clicking on this panel provides information on checking for Updates, performing updates and an update history for the machine. (1) Clicking on the Update Panel brings up the following screen.



Update from USB (1)

Firmware updates can be uploaded to your HM-5940 from a USB drive. Firmware updates are available for download from our website at: <https://www.humboldtmg.com/support/software.php>.

Once on this page, click on the Elite Series Firmware tab. You will see a list of Humboldt Elite Series machines. Click on the HM-5940 Current Version link and the firmware update will begin to download to your computer. Once the download is complete. Load the file onto a USB thumb drive and insert the thumb drive into the USB port on the front of the HM-5940. With the USB thumb drive inserted into the USB port, click on Update from USB.

A window will open and you will see a list of Updates. Select a file to use for your update and click the Select button.

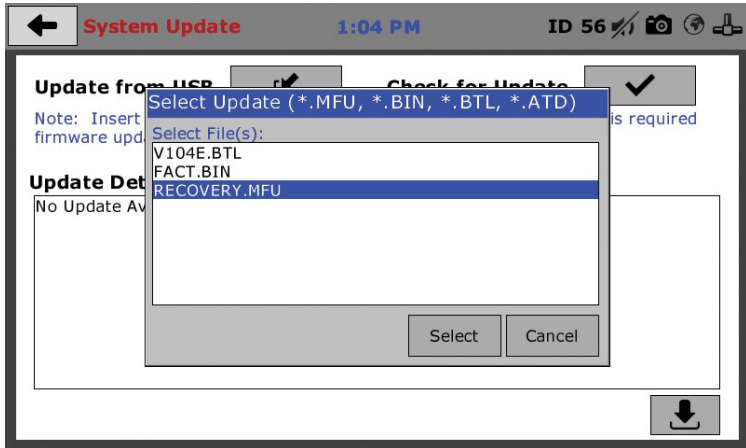

The update process will begin. This may take several minutes. Your HM-5940 may reboot several times during the update, do not turn off or reset machine during this process as this can cause the update to fail preventing the machine from functioning properly.

Check for Update

It is recommended that you update your HM-5820 firmware periodically. Checking for firmware updates every other month should be sufficient to keep your system up to date.

Warranty

Humboldt Mfg. Co. warrants its products to be free from defects in material or workmanship. The exclusive remedy for this warranty is Humboldt Mfg. Co., factory replacement of any part or parts of such product, for the warranty of this product please refer to Humboldt Mfg. Co. catalog on Terms and Conditions of Sale. The purchaser is responsible for the transportation charges. Humboldt Mfg. Co. shall not be responsible under this warranty if the goods have been improperly maintained, installed, operated or the goods have been altered or modified so as to adversely affect the operation, use performance or durability or so as to change their intended use. The Humboldt Mfg. Co. liability under the warranty contained in this clause is limited to the repair or replacement of defective goods and making good, defective workmanship.

Humboldt Mfg. Co.

875 Tollgate Road
Elgin, Illinois 60123 U.S.A.

U.S.A. Toll Free: 1.800.544.7220

Voice: 1.708.468.6300

Fax: 1.708.456.0137

Email: hmc@humboldtmfg.com

Testing Equipment for



Construction Materials

HUMBOLDT

www.humboldtmfg.com